

Article number: 51030375000010

Description: Vibration damper GS-M2
75x40x2000-10, NR shore 57

Measures

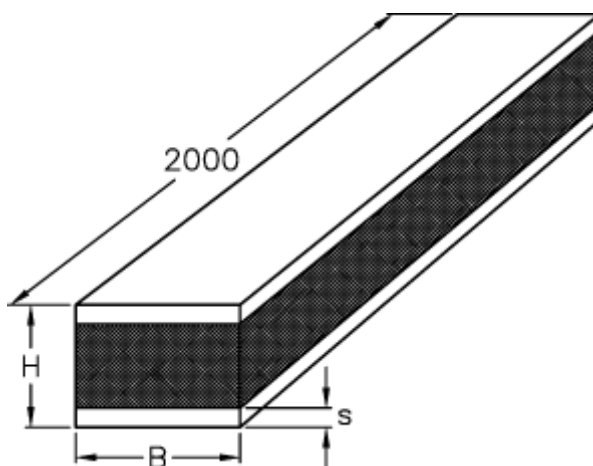

B = 75
H = 40
S = 10